



KONICA MINOLTA

AccurioPress
C7100/C7090

MAKE A POWERFUL IMPRESSION

RETHINK AGILITY



Giving Shape to Ideas

DISCOVER AGILITY THAT CREATES OPPORTUNITY

More profitable business through a press that works smarter not harder – this was key in the development of AccurioPress C7100 and AccurioPress C7090. With a focus on optimizing performance, offering new and advanced print products, and growing the entire business. With the AccurioPress C7100 series, you serve more customers and complete more jobs with innovative technologies that power your success.

INTELLIGENT AUTOMATION

By instantly detecting the precise stock you're using, the optional Intelligent Media Sensor IM-101 significantly reduces production time. At the same time, the optional IQ-501 Intelligent Quality Care Unit ensures perfectly consistent colour quality and front-to-back registration on every print in real time. And as there's no recalibrations or inspections mid-run, you'll benefit from improved productivity as well.

ENHANCED FINISHING

The optional in-line TU-510 4-edge trimming unit cuts, creases and perforates to produce stunning full-bleed trimmed book jackets, imposed cards, business cards, coupons and more. Removing the need for off-line finishing means fewer operator touchpoints for faster and more efficient print runs.

FLAWLESS QUALITY

Our latest Simitri V toner is eco-friendly and formulated for performance. Fast melting, energy efficient and low maintenance, it reproduces superb quality on a wider range of media up to 400 g/m². Combined with an output resolution of 3,600 dpi equivalent x 2,400 dpi, you will get outstanding results even from the fastest, longest print runs.

ADVANCED CAPABILITIES

With auto-duplex banners up to 900mm and the flexibility to handle embossed and textured media, its handling so simple that one operator can run even the most complex projects. So, why not say yes right now to more opportunities that will grow your business!

EXCEPTIONAL DURABILITY

Reliability drives profitability. Among the new technologies built into the engine are a more durable lubricated drum, double corona wires with automatic cleaning, an optimized paper transport solution, and a double swing registration system for improved paper compatibility and feeding accuracy.



INNOVATE PRINT RETHINK TECHNOLOGY



Intelligent Quality Care

The IQ-501 Intelligent Quality Care Unit takes color consistency and registration accuracy to the next level. With highly automated image registration and color control, a closed-loop system that constantly monitors and adjusts printed output, and automated color calibration and profiling, IQ-501 delivers streamlined operator time, reduced print waste, and industry-leading productivity!



Simitri[®] V

Simitri[®] V Toner

Konica Minolta's innovative Toner technology Simitri[®] V gives superb print quality and an offset matte finish. Furthermore it supports the high productivity of AccurioPress C7100 series and it requires a lower fusing temperature which reduces the energy consumption of the system and the impact of the printing process on the paper. Simitri V was designed to easily follow the surface of the paper or substrate to guarantee best possible print quality on embossed, structured or recycled materials.

S.E.A.D. X Image Processing

Konica Minolta's own advanced colour processing technology of the fifth generation is called S.E.A.D. X, which stands for "Screen-Enhancing Active Digital Process", and combines an array of technical innovations to guarantee truly exceptional colour reproduction at top speed.

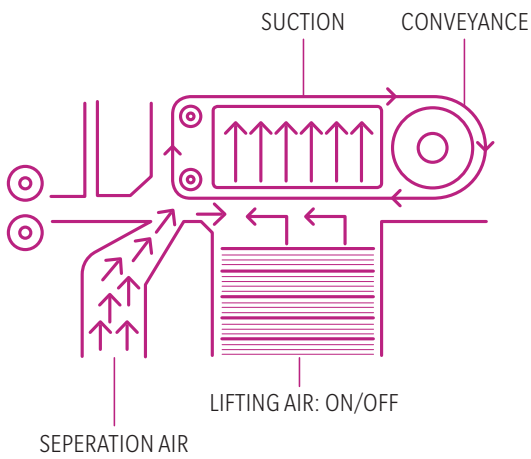

Vacuum paper feeding

It is essential for high-volume printers to feed each and every sheet smoothly and precisely through the digital press. To ensure this, Konica Minolta offers professional and intelligent paper feeding for all formats up to 900 mm length that builds upon proven concepts, including a combination of air separation of sheets and suction/vacuum feeding. This ensures smooth paper processing throughout the printing system. For efficient printing on offset preprinted and coated stock as well as under high humidity conditions, an optional heating unit can be added to enhance this precise technology further.

Media Detection Sensor

The optional media sensor IM-101 automatically detects the type, weight, thickness and surface of each substrate, and proposes the appropriate paper

settings from the catalogue, which makes wrong paper settings a thing of the past avoiding misprints and waste.

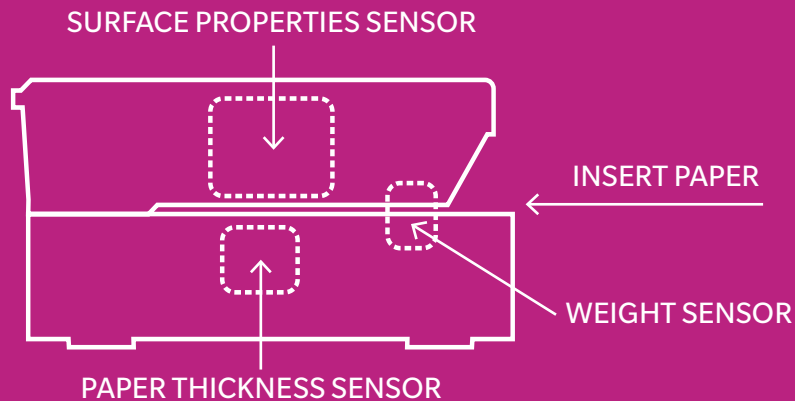





STATE-OF-THE-ART- PRINT-SERVER

RETHINK PRODUCTION PRINTING

THE IC-609 KONICA MINOLTA OWN CONTROLLER

The Konica Minolta IC-609 print controller brings powerful workflow benefits – including 2,400 dpi printing at full rated engine speed, high-speed RIP processing, enhanced accuracy in colour reproduction, colour management functions and full compatibility with print engine on-board job control and editing functions.

IC-318L EFI FIERY CONTROLLER

Reduce labour costs, cut turnaround times, and minimize errors and paper waste with the advanced job management and workflow automation that the Fiery® IC-318L provides. Streamline your job layout with the Fiery's instant visual preview and advanced make ready capabilities. What's more, supporting industry-leading variable data printing (VDP) formats, the Fiery also produces personalized short-run jobs profitably.

IC-319 EFI FIERY CONTROLLER

The top-of-the-line Fiery® IC-319 will improve your bottom line with best-in-class processing, outstanding colour and time-saving workflows. If you want the best out-of-the-box colour consistency and accuracy with powerful colour matching, profiling, and automated calibration, look no further! With EFI™ management information systems and web-to-print solutions, the IC-319 eliminates touch points and optimizes production; plus it integrates with industry-leading prepress workflow solutions.

IC-316 CREO CONTROLLER

The Creo® IC-316 external print controller supports perfect variable data printing integration and is the ideal choice for hybrid prepress workflows. Beyond that, the Creo features advanced spot colour profiling, a complete Pantone GOE library, Remote Site Manager status tracking, JDF connectivity, Creo job ticket software, and much more.



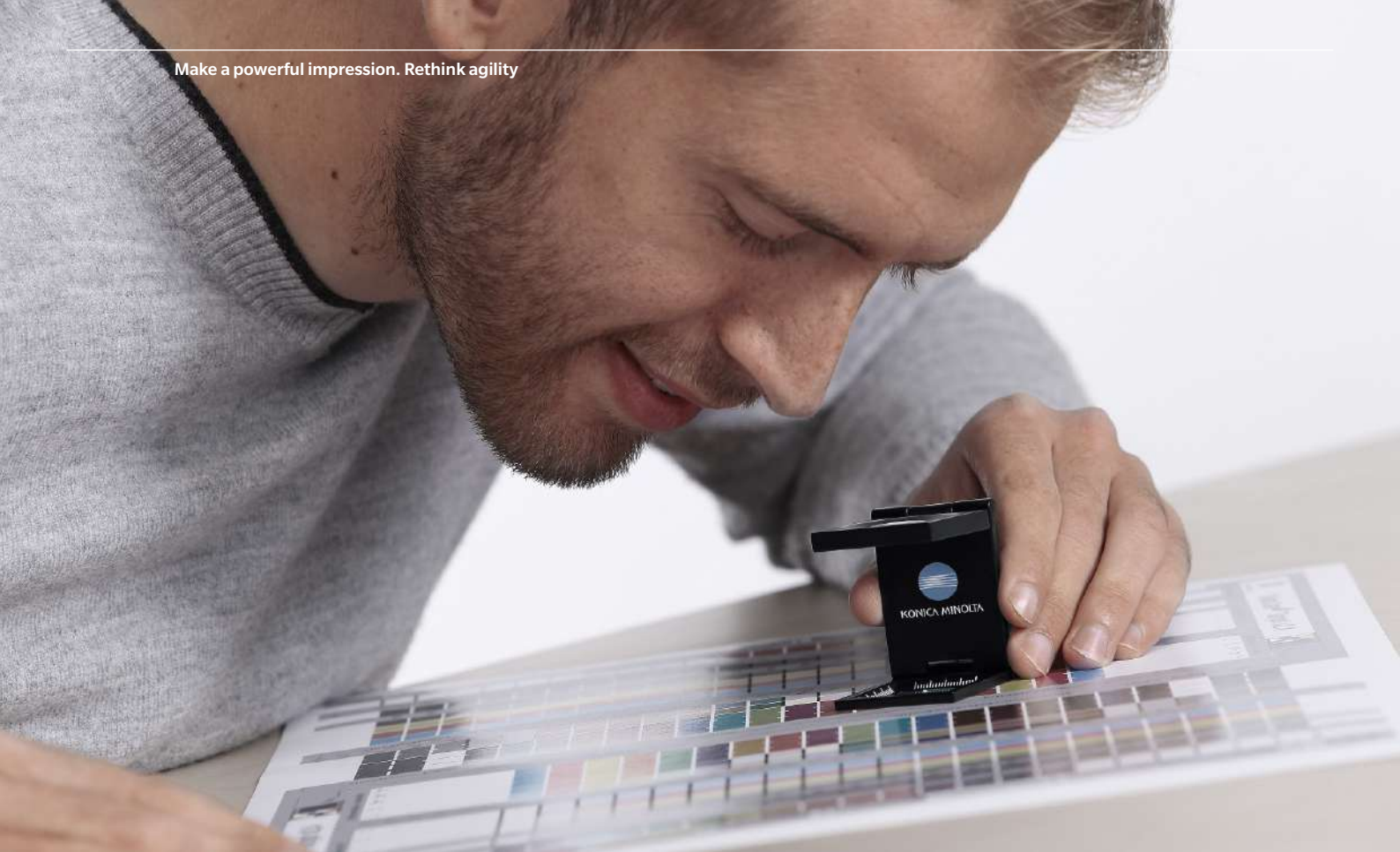

STREAMLINE YOUR PRODUCTION

RETHINK YOUR WORKFLOW

Evolving from our expertise in precision technologies and more than 80 years of experience in the printing and imaging industries, AccurioPro reflects our commitment to developing market-shaping technology with functionality that enables your business to grow. AccurioPro, Konica Minolta's suite of digital solutions for professional printing, is one of the industry's most versatile and powerful tools to optimise print production operations and workflows.

For all printing companies looking to integrate their printing as well as businesses that use digital printing to produce their own in-house publications and promotional materials, AccurioPro boosts speed and

efficiency, expands capabilities and services, and reduces the need for operational manpower – all of which will help improve your profitability!

The comprehensive suite of features that AccurioPro offers includes centralised management, software for automated workflow processing, colour management, seamless integration of different printing technologies and full connectivity of all Konica Minolta printing systems used from input to output.

AccurioPro

POSSIBILITIES

RETHINK YOUR WORKFLOW

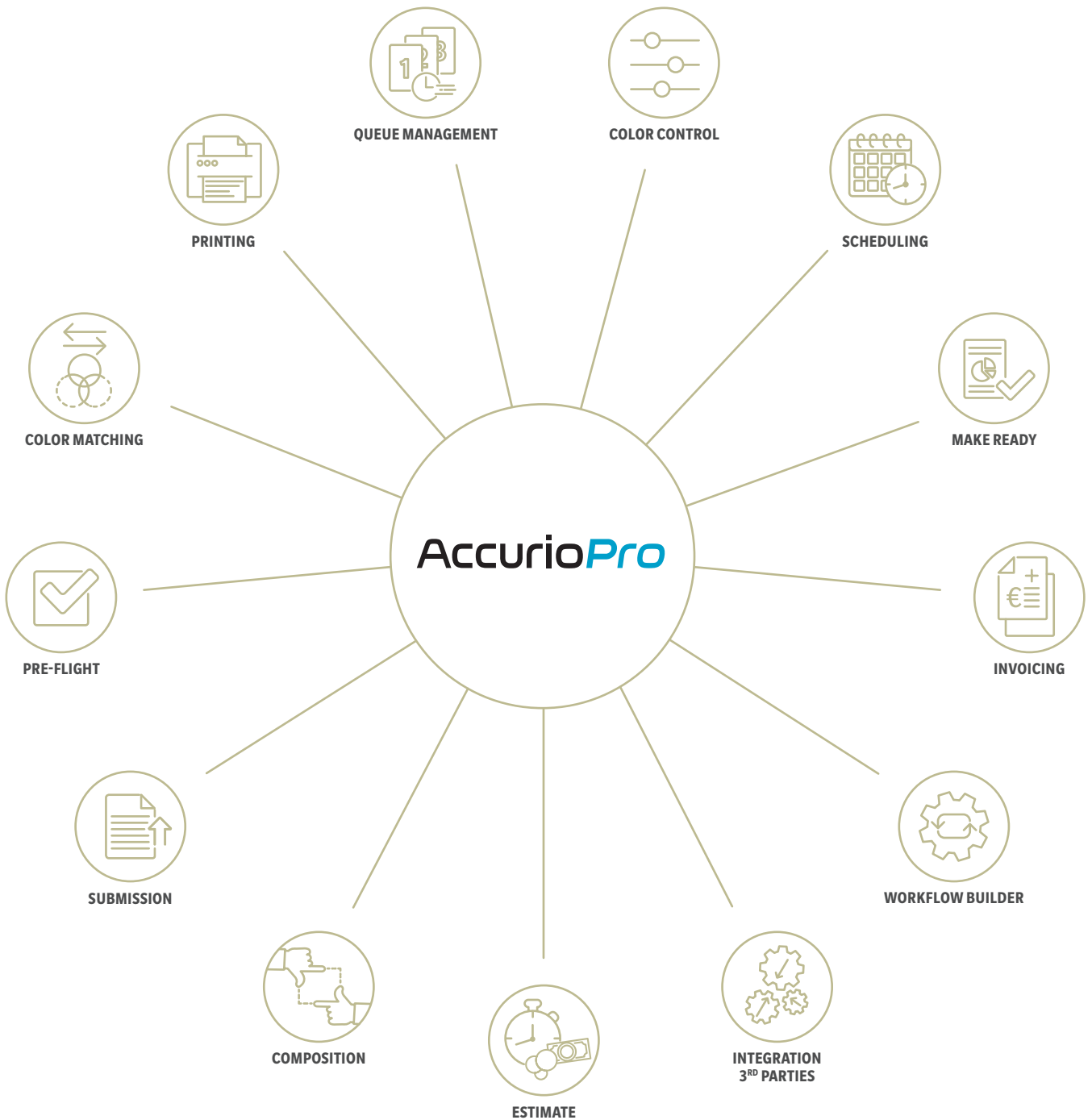

YOUR ADVANTAGES WITH THE AccurioPress C7100 / C7090

RETHINK PRODUCTION PRINTING

READY-MADE PRINT PRODUCTS

- 50-sheet booklet making with front trimming and optional creasing, slitting and spine corner forming
- Perfect binding for books of up to 30 mm
- 100-sheet stapling with cutting mechanism
- 102-sheet auto ring binding
- Automated inline business card and postcard cutting
- Full bleed banners, A3 and A4 posters

DURABLE PERFORMANCE

AccurioPress C7100

- Duty Cycle of up to 1.8 million prints
- Up to 100 A4 colour pages per minute
- Up to 53 SRA3 colour pages per minute

AccurioPress C7090

- Duty Cycle of up to 1.62 million prints
- Up to 90 A4 colour pages per minute
- Up to 48 SRA3 colour pages per minute

GEARED-UP FINISHING

- Multi (GBC) punching and 2- & 4-hole punching
- 6 different types of folding
- 3rd-party Products
- Large-capacity stacking
- 2 Perforations in feed direction, 5 Perforations in Cross feed direction
- Up to 5 Creases downwards or upwards

SIMPLY EFFICIENT

- Automated engine linearisation
- Automated duplex registration
- Automated profiling
- Real-time adjustments
- Purge function

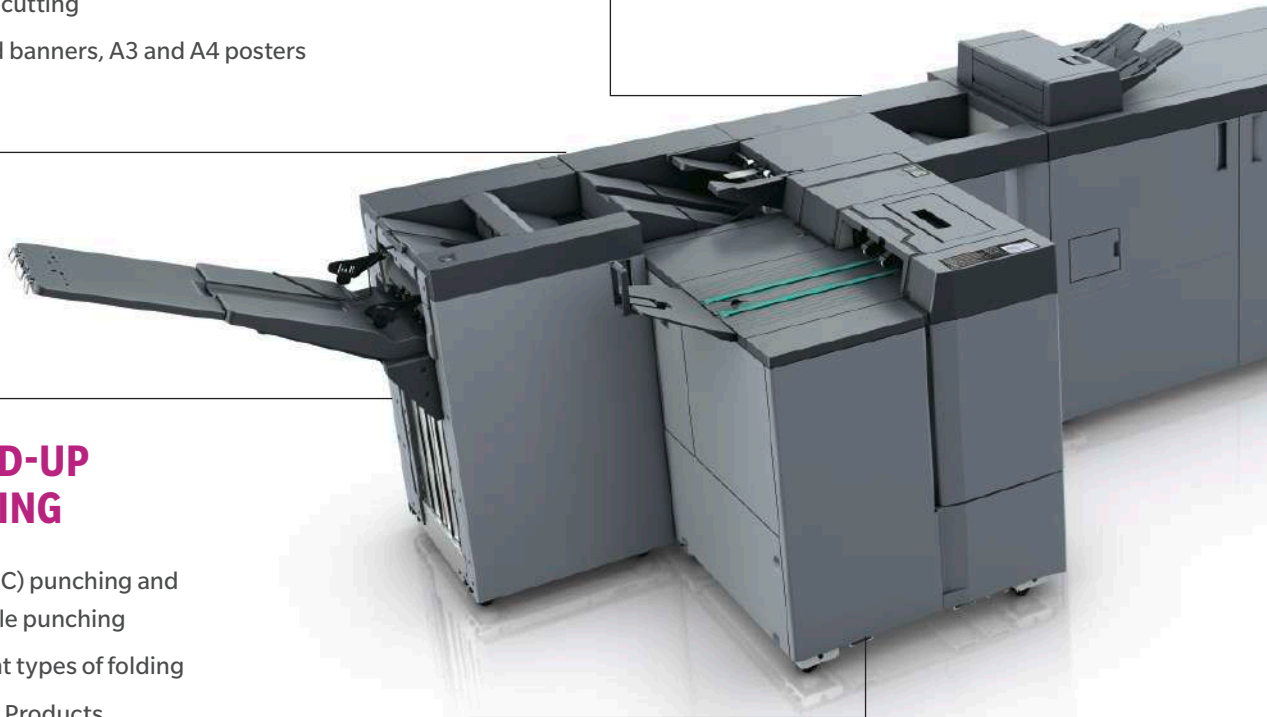

HIGHEST RELIABILITY

- Long-life platform, long-lasting parts and consumables
- Accurate front to back registration
- For prints with maximum efficiency
- For lucrative short-run printing

HIGH-END PRINT CONTROL

- Flexible choice of controller technology: EFI®, CREO® or proprietary Konica Minolta controller
- Integration into hybrid workflows

EASE OF USE

- Simple paper catalogue settings
- Operator Replaceable Parts
- Auto Inspection Technology

PERFECT IMAGE QUALITY

- S.E.A.D. X
2,400 x 3,600 equiv. dpi x 8bit
- Simitri V toner technology
- Image density control technology

SOPHISTICATED MEDIA HANDLING

- Automatic media recognition
- Air-suction feeding technology
- Up to 15,150 sheets paper input capacity
- Up to 11 paper input trays
- Up to 2,300 sheets paper input for long sheets (up to 900 mm)

COMPREHENSIVE MEDIA PROCESSING

- Up to 400 g/m² paper weight in simplex and duplex printing
- Long sheet size of up to 1,300 mm (duplex up to 900 mm)
- Reliable thin paper feeding through air-blow fusing separation
- Envelope printing
- Embossed paper support
- Optional inter-cooler curl eliminator



FINISHING & FUNCTIONS



Letter fold



2/4 hole Punching



Two-point stapling



Corner stapling



Stacking



Booklet



Trimming

Open stacker
OT-512



Staple finisher
FS-532m



Ring binding unit
MB-200 Max Finisher



Staple finisher
FS-541



Booklet making unit
SD-513



Stacking unit
LS-507



Folding and punching unit
FD-503



Perfect binding unit
PB-503



Booklet making unit
SD-506



Trimming unit
TU-510



Ring binding unit
GBC G1





























Multi punching unit
GBC G2



Multi purpose stacker
Plockmatic MPS-130



	 Creasing	 Slitting	 Perforation	 Square-folding	 Multi Letter fold-In	 Post Insertion	 Perfect Binding	 Wire-binding	 Ring-binding	 Multi-punching	
											ENTRY
											
											MID
											
											
											
											
											
											HIGH
											





10 GOOD REASONS FOR AccurioPress C7100 SERIES

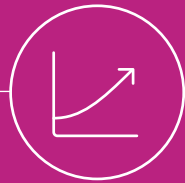

1. BUSINESS EXPANSION

Compatible with thin to thick media and superior banner printing capabilities



2. INTELLIGENT AUTOMATION

Minimize preparation time with easy and quick setup routines, e.g. for media, colours, registration



5. NEW PRINT PRODUCTS

Extend your offerings with textured media, envelope and long sheet duplex printing



6. HIGHEST RELIABILITY

Durable design and accurate registration for quality products with minimum waste



3. AUTOMATED FINISHING

Many unique inline finishing options to create ready-to-ship booklets, perfect bound books, ring binding, business cards or full bleed banners and many more

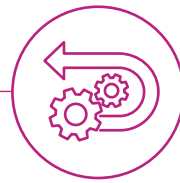

4. FAST TURN AROUND

Same high engine performance on all kinds of media combined with closed loop quality control and inspection technology

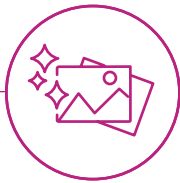

7. SUPERB IMAGE QUALITY

Simitri V, high print resolution and Konica Minolta's very own imaging technology guarantee happy customers



8. WORRY-FREE OPERATION

Real-time quality control for consistent and faultless print products



9. INCREASED UPTIME

Long-lasting consumables, high paper input capacity and dependable productivity secure uninterrupted production



10. EASE OF USE

Even novice operators will get very good and consistent results at the tip of a finger.

TAKE LEADERSHIP AND RESPONSIBILITY

RETHINK TOMORROWS BUSINESS

MADE YOUR BUSINESS

Commercial printers

The AccurioPress C7100 series supports you in growing your business and getting the most out of your investment. Its high speed, high productivity and high uptime help you achieve shortest turnaround times, while the great media flexibility with stocks of up to 400 g/m², long sheets of up to 1,300 mm, envelopes and structured media will further enhance the variety of our print offerings. Colour quality issues are a thing of the past as the AccurioPress C7100 includes numerous auto control and adjustment features. What's more, an inspection system can be applied to make sure only impeccable prints leave your shop.

CRDs

The AccurioPress C7100 series provides the highest degree of automation and produces quality on the highest level. With its professional inline finishing, you can create ready-made products at the push of a button; and the Intelligent Quality Optimizer IQ-501 makes sure that the print quality is automatically set, monitored and continuously corrected. The versatile media flexibility and high productivity make the AccurioPress C7100 series a solid and lucrative investment for the future.

DESIGN FOR OUR PLANET

Konica Minolta promotes sustainable development and integrates environmental and social perspectives into its business strategies. You can rely on Konica Minolta products to underpin your green strategy to build your business.

Committed to help prevent global warming, Konica Minolta strives to reduce CO₂ emissions during product manufacture, product distribution, at the sales stage, and during product use – with even stricter targets than demanded by the Kyoto Protocol. Enabling carbon neutrality, Konica Minolta offers its customers the offset of unavoidable CO₂ emissions for production printing. Together with the experts from Climate Partner, Konica Minolta proposes a new and profound eco concept for our professional production presses.





CONTROLLER AND OPTIONS

RETHINK THE NEEDS

FIERY IMAGE CONTROLLER IC-319

Architecture	External
OS	Windows 10
CPU	Intel® Xeon 5118
Clock speed	2.3 GHz
RAM std	32 GB
HDD	4,5 TB
Page-description language	Adobe PostScript 3; PDF v1.7; APPE v5; PDF/VT-1/-2 v3; PDF/X1a,3,4; PPML v3.0; PCL; Creo VPS
Applicable OS	Windows 8.1/10; Windows Server 2012/R2/2016/2019; Mac OS X 10.11-14

FIERY IMAGE CONTROLLER IC-318L

Architecture	External
OS	Windows 10
CPU	Intel i7-6700
Clock speed	3.2 GHz
RAM std	16 GB
HDD	1 TB
Page-description language	Adobe PostScript 3; PDF v1.7; APPE v5; PDF/VT-1/-2 v3; PDF/X1a,3,4; PPML v3.0; PCL; Creo VPS
Applicable OS	Windows 8.1/10; Windows Server 2012/R2/2016/2019; Mac OS X 10.11-14

CREO IMAGE CONTROLLER IC-316

Architecture	External
OS	Windows 10
CPU	Intel i7-8700
Clock speed	3.2 GHz
RAM std	20 GB
HDD	8 TB
Page-description language	Adobe PostScript 3; PDF v1.7; APPE v4.9; PDF/VT-1/-2; PDF/X1a,3,4; PPML v2.2; Creo VPS; AFP; IPDS; JPEG; TIFF (v6, 1bit)
Applicable OS	Windows 8.1/10; Windows Server 2012/R2/2016/2019; Mac OS X 10.11-14

KONICA MINOLTA IMAGE CONTROLLER IC-609

Architecture	Internal
OS	Linux
CPU	Intel Core i5 6500
Clock speed	3.2 GHz
RAM std	16 GB
HDD	2 TB (2 x 1TB)
Page-description language	Adobe PostScript 3; APPE (with UK-220); TIFF v6; PDF 1.7, X-1a, X-3, X-4, VT2; PPML 2.2; PCL 5c; XL; PCL XL; JDF/JMF
Applicable OS	Windows 8.1/10; Windows Server 2012/R2/2016/2019; Mac OS X 10.11-15

OPTIONS

KM image controller	IC-609
EFI external image controller	IC-318L
EFI external image controller	IC-319
CREO external image controller	IC-316
Paper Feeder Unit	PF-712
Paper Feeder Unit with Scanner	PF-713
Paper Feeder Unit	PF-812
Dehumidifier Heater	HT-506
Multi Bypass Tray	MB-511
Large capacity feeding unit	LU-208
Large capacity feeding unit	LU-208XL
Dehumidifier Heater	HT-518
Envelop printing guide	MK-746
Multi bypass feeding	MB-510
Intelligent Media Sensor	IM-101
Conveyance Unit	RU-518m
Humidifier	HM-103
Intelligent Quality Optimizer	IQ-501
Purge Unit	RU-702
Auto Inspection Unit	UK-301
Inspection Enhancement kit	UK-311
VDP Verification kit	UK-312
Envelope Fusing Unit	EF-108
Output Tray Unit	OT-512
Long Sheet kit (Input)	MK-760
Long Sheet kit (Output)	MK-761
3rd party Interface	MK-737
Relay Unit	RU-510
Stapling Unit	FS-541
Stapling Unit	FS-532m
Saddle Stitcher kit	SD-510
Punch kit	PK-525
Mount Kit	MK-732
PostInsertor kit	PI-502
Press and trim kit	PT-220
Corner forming kit	SF-204
Folding and Punching Unit	FD-503
Booklet making Unit	SD-506
Booklet making Unit	SD-513
Folding kit	FD-504
Trimmer kit	TU-503
Creaser kit	CR-101
Stacking Unit	LS-507
Handcart	LC-502
Perfect Binding Unit	PB-503
Trimmer Unit	TU-510
Creaser kit	CR-102
Trimmer kit	TU-504
Banner kit	MK-764
Job Separator kit	JS-507
Creaser kit upwards	CR-103
Perforation kit Horizontal	PE-101
Perforation kit Vertical	PE-102
Scrap ejection kit	MK-765
GBC Binding Unit	G1
GBC Punching Unit	G2
Max Binding Unit	MB-200



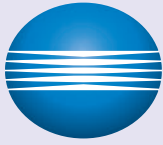

KONICA MINOLTA

TECHNICAL SPECIFICATIONS

RETHINK PRODUCTION PRINTING

SYSTEM SPECIFICATIONS

Resolution	2,400 x 3,600 equiv. dpi x 8 bit
Paper Weight	52–400 g/m ²
Duplex Unit	Non-stack type; 52–400 g/m ²
Paper sizes	330.2 x 487.7 mm 330.2 x 900 mm (max. duplex) 330.2 x 1,300 mm (max. simplex)
Paper input capacity	15,140 sheets
Main unit dimensions (W x D x H)	800 x 1,138 x 1,478 mm
Main unit weight	335 kg

PRODUCTIVITY

AccurioPress C7100	
A4 colour - max. per minute	100 ppm
A4 mono - max. per minute	110 ppm
SRA3 colour - max. per minute	53 ppm
SRA3 mono - max. per minute	58 ppm
A4 colour - max. per hour	5,613 pph
A4 mono - max. per hour	6,103 pph

AccurioPress C7090	
A4 colour - max. per minute	90 ppm
A4 mono - max. per minute	110 ppm
SRA3 colour - max. per minute	48 ppm
SRA3 mono - max. per minute	58 ppm
A4 colour - max. per hour	5,047 pph
A4 mono - max. per hour	6,103 pph

- All specifications refer to A4-size paper of 80 g/m² quality.
- The support and availability of the listed specifications and functionalities varies depending on operating systems, applications and network protocols as well as network and system configurations.
- The stated life expectancy of each consumable is based on specific operating conditions such as page coverage for a particular page size (5% coverage of A4). The actual life of each consumable will vary depending on use and other printing variables including page coverage, page size, media type, continuous or intermittent printing, ambient temperature and humidity.
- Some of the product illustrations contain optional accessories.
- Specifications and accessories are based on the information available at the time of printing and are subject to change without notice.
- Konica Minolta does not warrant that any prices or specifications mentioned will be error-free.
- All brand and product names may be registered trademarks or trademarks of their respective holders and are hereby acknowledged.



LET'S TALK

Contact us to find out how we can support, protect and optimise your business today and in the future:

info@konicaminolta.co.uk

www.konicaminolta.co.uk/en-gb/professional-printing

Konica Minolta Business Solutions,
Miles Gray Road, Basildon, Essex, SS14 3AR

Giving Shape to Ideas